



APPLEBOX

The Basic DISK II Pages Speedadjustment, Trackalignment, Cleaning and Service project

page about calibrating the track zero

I really don't want to discourage anybody, but the task of recalibrating the track zero is really tricky, it requests some experience and its only possible to execute the task with special software and special disks - and its also strongly recommended that the user is able to handle (with at least basic knowledge of) and work with an oscilloscope. there are different kinds of attempt to the task depending to the available items. If one of the listed items is missing it still might be possible to solve the task - but it becomes more complicated requests more time and more advanced experience to overcome such a handicap.

I will explain the different possible tasks again in the order sorted by difficulty from simple to more difficult and finally i will explain the "mission impossible" (thats an attempt with missing tools and "try and error" method to get at least a drive able to read and write but but not with accurate calibration but rather more to say a "somehow acceptable result").

First of all again we'll start with the basics - so lets examine how the Apple works normal, when it starts accessing a disk and what part of the game the track zero plays in that game and what happens if the track zero is not recognized by the system.

Any kind of access to the disk performs the following steps:

1. recalibrate diskdrive (thats the knocking noise when the read/write-head is pulled back to the outside of the disk and after the read/write-head sled hits with the positioning-limiter some times the positioning stepper motor and then moves the sled one step ahead towards the center and assumes this to be the track zero)
2. the controller tries to read this track and expects this track to contain the information determined to be at track zero (this information track should contain the FAT and the information of the diskformat (i.e. dependent to the operationsystem - how many tracks, the amount of sectors per track, the track where additional parts of the FAT is allocated and further information *)

remark: FAT = File Allocation Table

* = further more detailed information at the end of this page !

The information in this track zero is normally written first time to the disk when disk becomes formatted or initialized by the INIT-command. Thereafter this track becomes updated, if the contents of the disk is modified (i.e. update amount of free sectors).

3. Then the read/write-head-sled is moved ahead towards the inner part of the disk to the desired track and sector to start reading or writing to the disk.
4. In case of booting from disk its the same procedure and the steps from 1 to 3 are repeated step after step to get the data from the FAT, reading the sectors where DOS is stored sector by sector until DOS is loaded completely to memory, then the computer performs the instructions of DOS itself - i.e. it looks for the program that was left as initial startup program in DOS - mostly common the "hello" program in DOS or the SYS-file in proDOS.

*) this explanation is at the very end of the page !

If one of the steps above fails the computer or DOS will display an errormessage If the track zero isn't found - the ROM F8 with the autostart routine will display the message "no System" or similar - if the mistake occurs later i.e. a part of DOS was not loaded the system will display a message like "read error" and if the mistake happens more later i.e. DOS loaded but "hello" not loaded due to malfunction the message will be something like "read error" or "missing file" or "file not found". In some occasions DOS simply crashes to the monitor-prompt.... this is for example a common kind of proDOS to crash.... with some experience and advanced knowledge you might be able to determine where the crash occurred by the adress displayed at the monitor prompt.... - but thats another story....

Before we start talking about the hardware here some things to remember / keep in mind:

Of course before taking next steps a cleaning and speedadjustment should be performed just to make sure that none of the other mistakes cause errors and making proof of the fact that the drive will be useable after readjusting the track zero... (- at least, if you have another drive to boot from).

Although a drive might be misaligned - it still might be used.... the trouble is just that it can't read disks from other systems and that disks written with this disk can't be recognized or read by other drives (so at least this should be detected before starting to attempt the hardware..... - if a second drive is available that is aligned proper you should set that drive to be first drive and move the misaligned drive to the second place to checkout some basic functions: does the drive pass the task of formatting or INIT'ializing a disk and can the drive read back data that has been written to this disk by itself (i.e. not from another drive written) ? Does it pass for example a speedtest and certify correct speed ? If it does and if the first drive can read write disks that can be exchanged with other drives because it is aligned correct, do you exchange disks containing data with other systems ? If not - you could for example dicide to use the other misaligned drive exclusive for own data and abuse that drive as a kind of encryptic security system, being sure nobody can access your private data

Disks could be marked with special sign on label to indicate with which drive they may be used....

Bear also in mind if you are using ADT this whole trouble might not bother you, if the disks you use are generated and used only by this drive... the trouble of misalignment only affects to you, when there is somehow a use with other drives too.....

If you have judged this facts and dicide to proceed and go ahead to align the track zero, then go ahead with this page...

Simplified Schematic of Diskettes

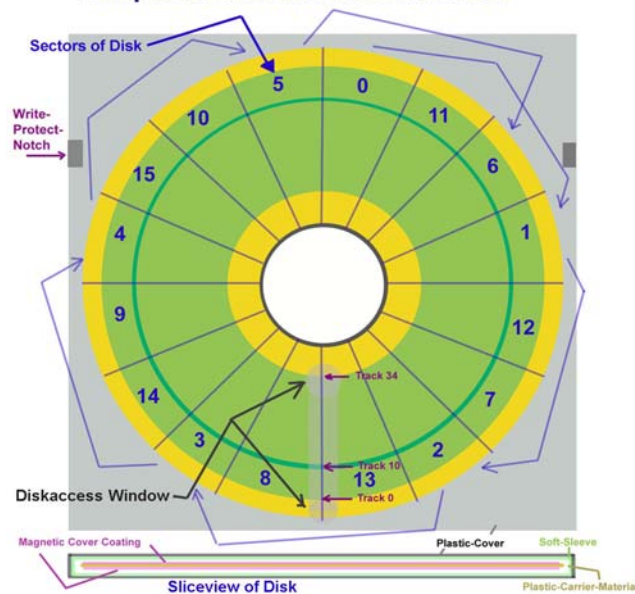

So now after this basic explanation lets get to the hardware part with pictures and connect that with the explanation above.....

First of all looking to the picture at the right side - those parts that are not within the game of alignment have been covered with gray.

If you can't read or remember the comment just switch back to the picture at page 1 to read within the large picture.

For this task only three groups become important:

the fixed group of the 2 steelbars (1) and the topframe (2) that guide the sled.

the sled itself (3), that carries the movable parts of the drive (on top: diskcenteringwheel (4), and the lever with the disk-pressdown-foam (5) - on the bottom: the read/write-head (6), the sledcarrier (7) with the guidance notches (8) running along the steelbars (1), and very important: the steelspringplate (9) with the slideball (10), and the hardplastic positioningdisk (11) with the guidingnotch for the slideball (12), and the slidinglimiter (13) and

at the bottomsides the positioningsteppermotor (14) with its alignment screws (15).

and now the pictures in detail with the mentioned parts (1) to (15):

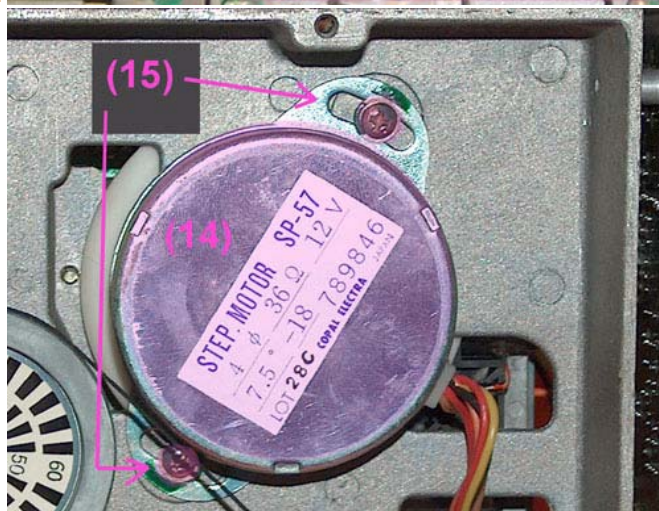
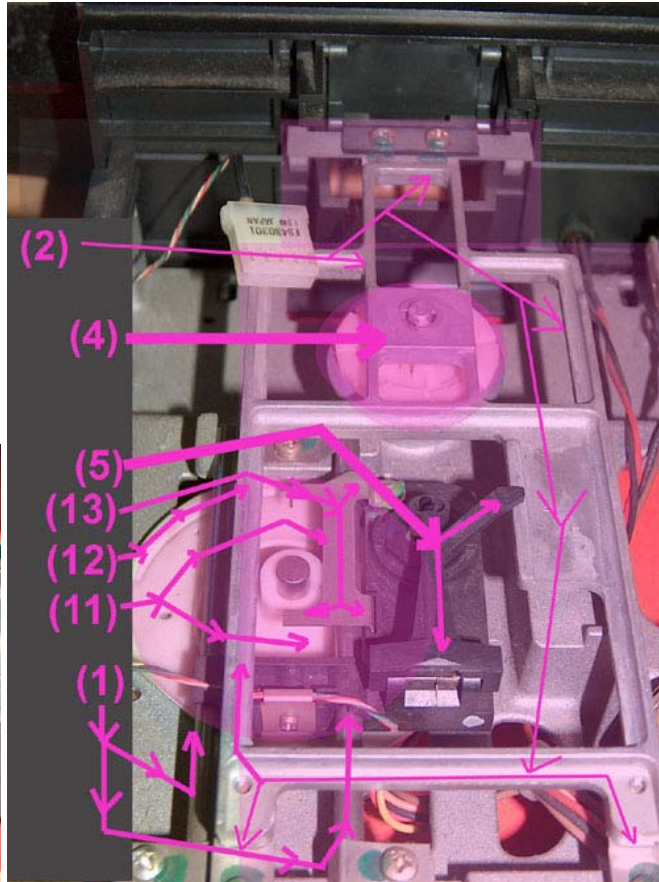
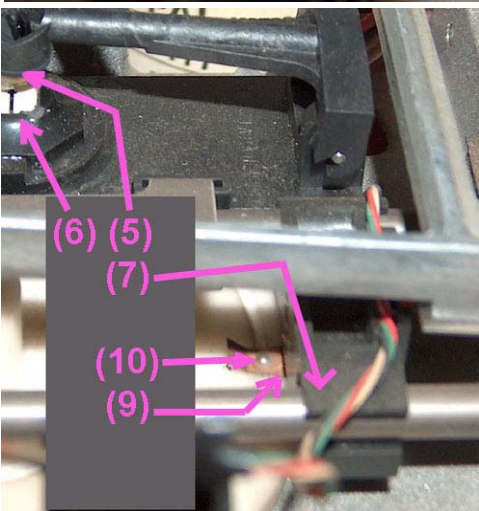
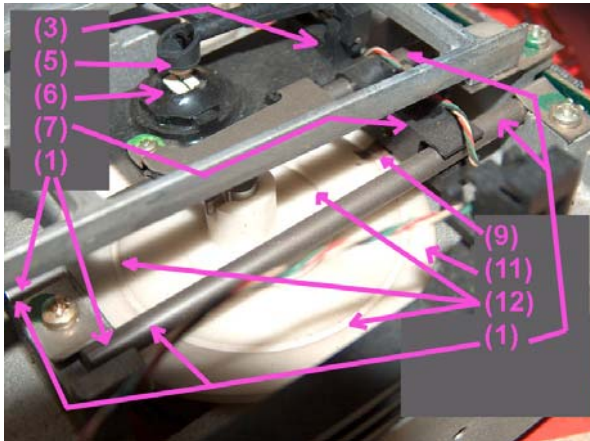
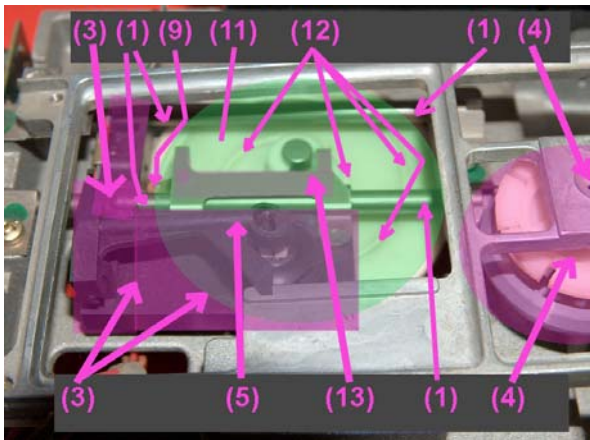
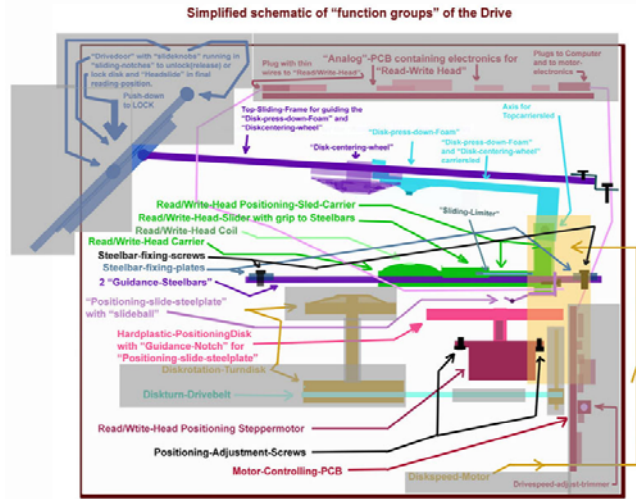

Required Tools

spacing template

Set with an .008 to .010 gage steel.

Apple says .010, but with .008 it will be rather better adjusted.

Such a tool isn't too expensive and you can get it at ebay for about \$5. Of course better ones will amount up to \$20 but probably you can lend it from somebody, who is familiar with repairing himself cars or motorcycles, because this tool is very common there - its needed to set adjustment at the mechanic of the ignition-breaker.

Other possibility of substitute will be a small drill that you know that it has the requested diameter.



Parts to pay attention to **The numbers are corresponding to the numbers listed above !**

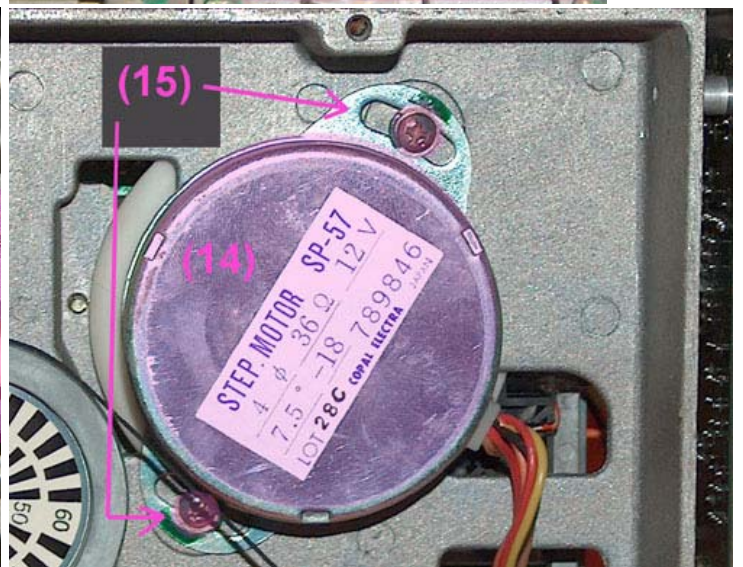
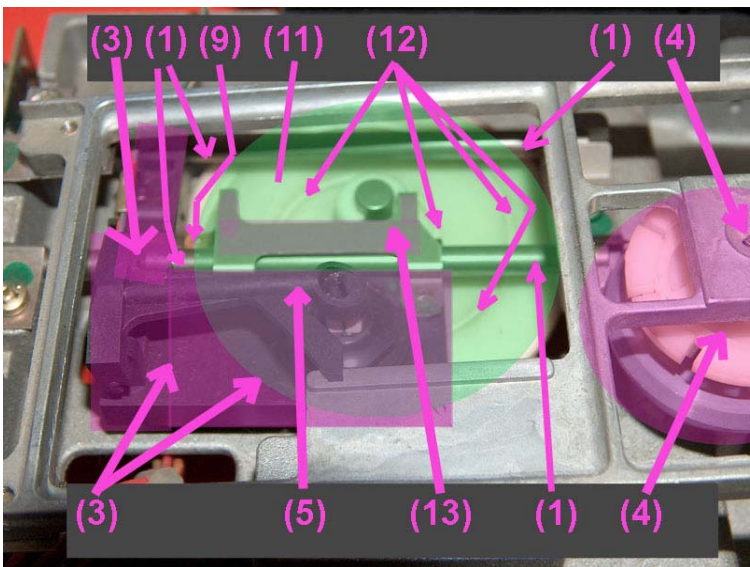
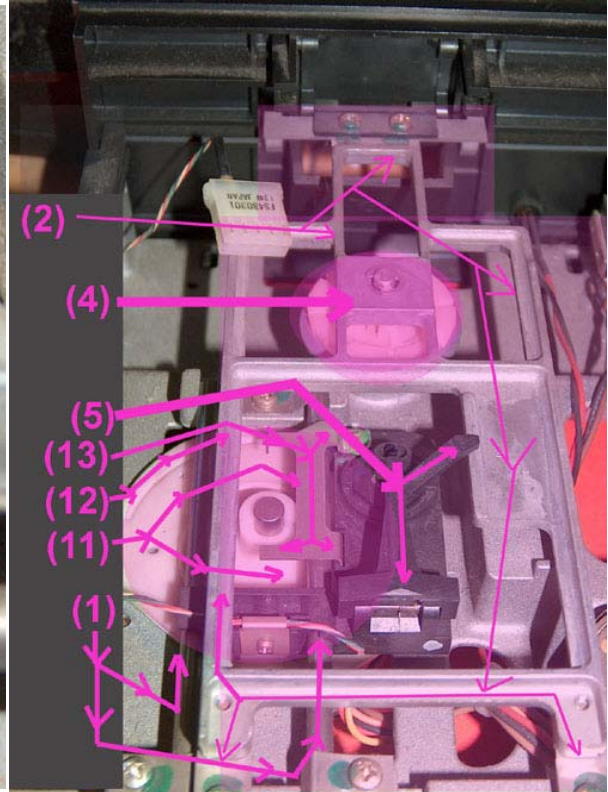
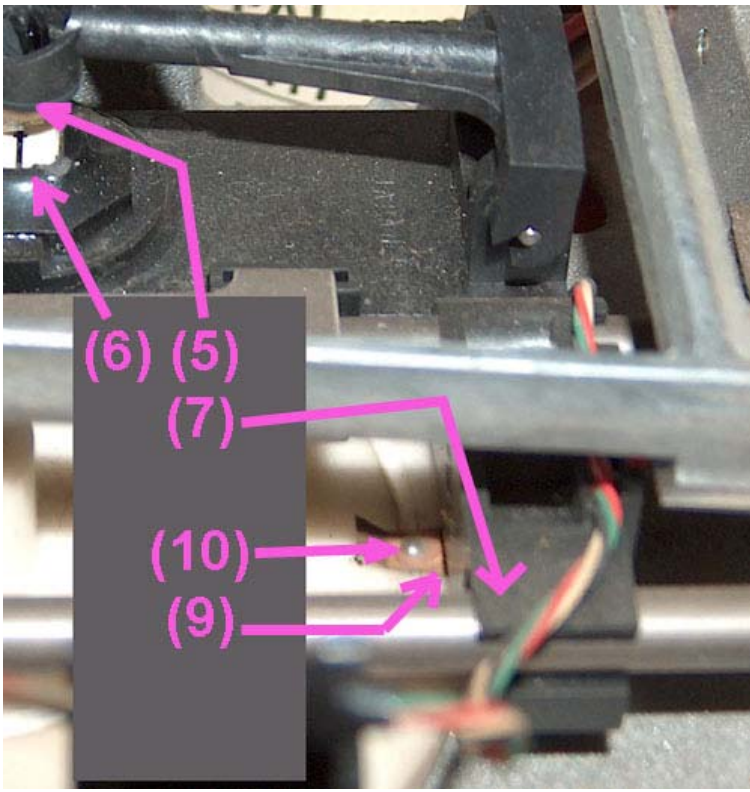

Dismounting the Drive

Dismounting Analogboard

The analogboard is rather simple to dismount: unplug at the front the cable to the read/writehead and pay attention not to issue any force to the thin cables themselves. The unplug the MotorPCB-cableplug in the center of the rear. Its a good idea to also unplug the cable to the controller. Then you might loosen the 2 screws at the front edges. The AnalogPCB then will slide forward toward the front out of the notches of the plastic Frame. Finally the drive then should look like this. Deposit the analogboard on a antistatic foam or in a antistaticslieve!

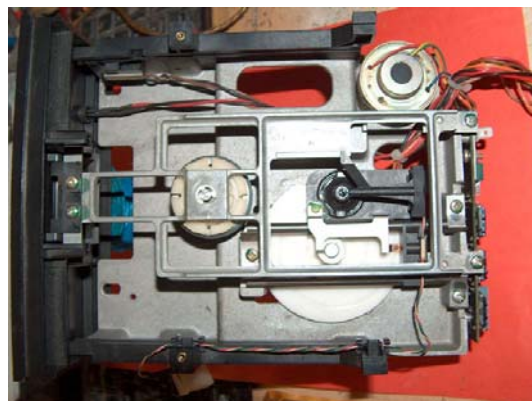

Next will be the dismounting of the topframe. Loosen the 2 screws at the rearside of the frame and the frame will slide with the frontdoor of the drive out of the notches of the frontpart of the drive. Be carefull at this step and don't damage the lever of the toppart of the sled that carries the diskpushdownfoam.

short remark besides: the diskpushdownfoam can become a source of trouble when using both sides of a disk.... because if turning around the disk to write at the opposite side at the same time that material slides along the side that has been written..... if material became bad it can scratch the surface of the disk.... so its very important that this material is soft and very clean (without any kind of dirt !). So keep care of this !

Dismounted Topframe

The next step will be explained besides the next picture.

First of all the cable to the Read/Write Head should be removed from the notches of the plasticframe very gently and carefully without damaging or tearing with force ! **That cables are thin and very sensitive to force.**

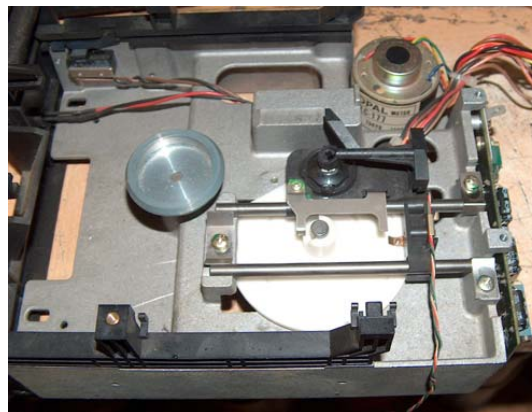

Dismounting Steelbars

In this step the steelbars will be dismounted. First the 2 screws at the rear of the drive shall be loosened and taken out. Then the centering screw with the centering blade at the front of the steelbars shall be released.

Then the steelbars can be removed together with the read/write-head sled and the bars can be pulled out gently and carefully. Be sure to avoid any kind of force against the read/writehead itself and handle this sled with very much care ! Protect the read/write-head from dust or dirt and deposit it while storage in a antistatic-bag !

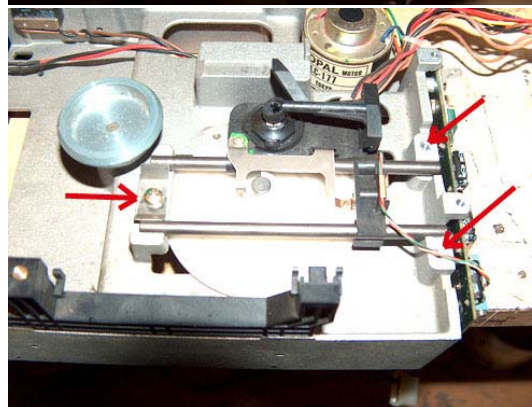

In this stage you will be able to see the entire positioningdisk - this one is still uncleaned and i want to guide your attention to the 4 small spotmarks drilled into the material. They mark 4 important points and are from the factory they indicate the position where the steelball of the steelspringplate should be when the sled is positioned to "fixpoints" at :

track 0
track 20
track 35
track 40.

This indicates that this positioningdisk was manufactured by a company, that also delivered this disk to thirdparty customers that made drives that also could handle 40 tracks (as most of the drives could...), the limitation to 35 tracks was also in those days rather unusual and it was related to the fact that Apple did not use specialized chips for diskhandling on their PCBs. So due to the use of standard chips the use of the "inner 5 tracks" (with more compressed data and higher demands to the electronic read/write compensation were higher and Apple decided to stay away from this inner tracks and believed them to be not safe with the DISKII analogboard.

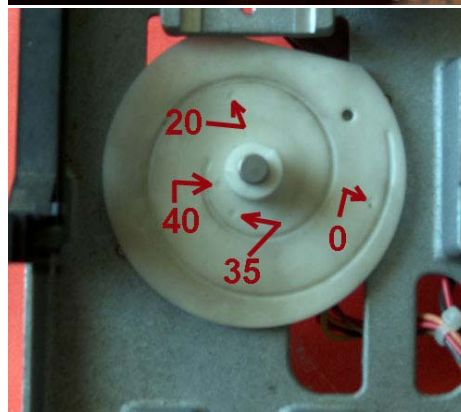

Cleaning and lubbing the positioningdisk

In case of doubt please reread the explanations at page 1. Don't use aggressive cleaning fluids ! The positioning disk was cleaned with isopropanol-alcohol (70%). Be sure to also clean every bit of dirt out from the sliding-notch ! Then apply very few grease in the notch and wipe it all along the entire notch with a Q-Tip. Thereafter clean again the entire top of the disk with a soft tissue and **just leave the grease within the glidingnotch**. Then the disk should look like the one in the picture at the right side.....

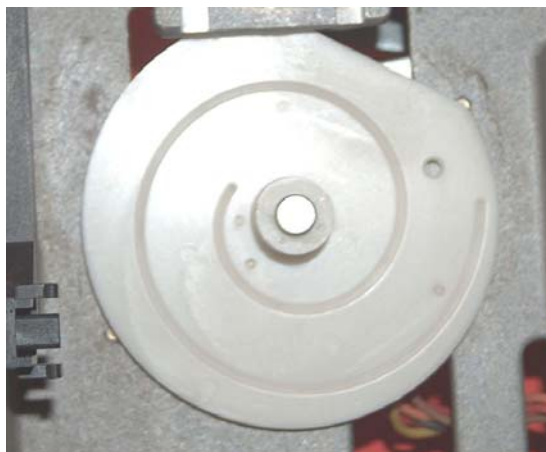

and cleaning the Read/WriteHead

Cleaning the read/write-head should be performed very careful.... avoid any kind of aggressive power..... don't produce scratches and only use very clean isopropanolalcohol from a pharmacy with 70% to 95%. Use a very soft tissue for cleaning and dry afterwards carefully and gently.

Then you can start to remount the drive again. NEVER touch the screw that fixes the slidinglimiter ! It is utmost important to keep this part exactly in the position as it left the factory !

The following pictures are just for information and display the parts in very detail to become familiar with the parts. Recognize the exact position and view of the steelspringplate ! This is the very part that is responsible for the positioning of the sled and therefor extremely important later when calibrating the track 0 ! The steelball runs within the guidingnotch of the positioningdisk. It might turn out that the steelspringplate became weak throughout the years so its a good idea to bendup that plate a little (not too much !) to make sure that later the steelspringplate will press down the steelball firmly in the guidingnotch - but not to firm ! If the positioningdisk is turned the sled must slide gently and perfect forward and backward - but the steelslideball shall remain within the notch !



The Read/Write-Headsled in detail

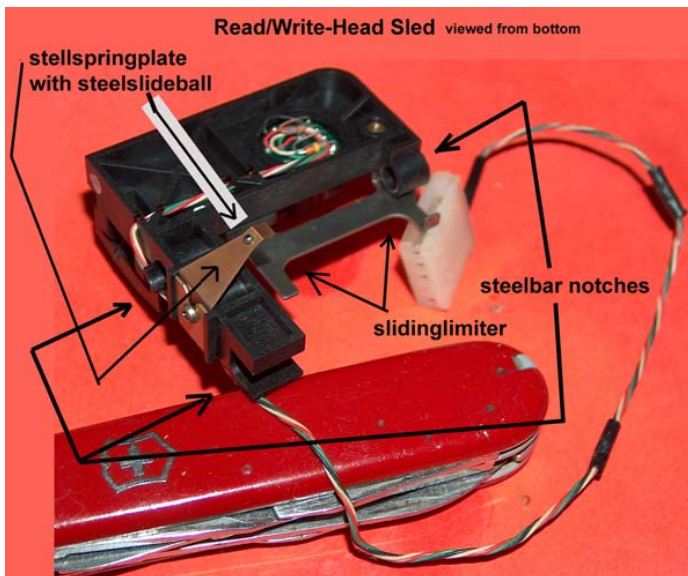

Read/Write-Head Sled with steelbars inserted
Viewed from Top Rear

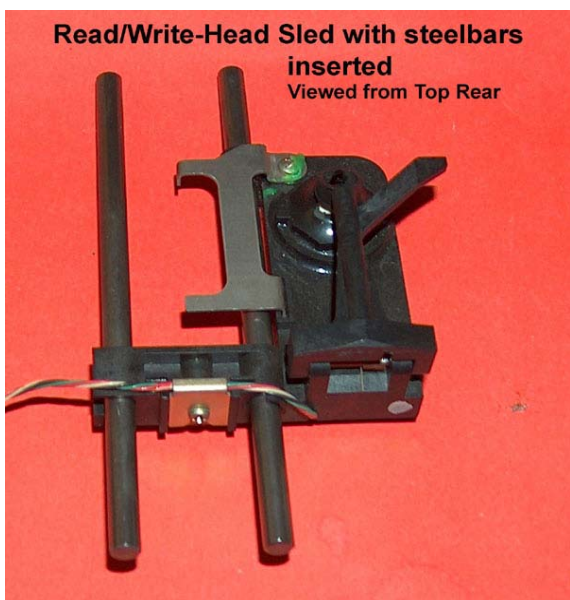

Remounting the drive for alignment

Put the steelbars again back in the correct position of the sled and apply a little grease to the steelbars and then just gently lay the steelbars in the position of the driveframe - at this moment the very position of the sled is not that important. Insert the screw and the alignmentplate at position 1 and start gently to turn the screw till it gets grip in the frame..... then gently tighten the screw - **but just that far that you still can adjust the position/length of the steelbars to make sure that they are plain with the backside of the frame.** Make sure that there is space between the slidinglimiter and the axis of the positioningmotor. Now tighten the screw! Next you should insert the screw and the fixingplate at position no. 2..... and tighten that screw. up to this moment the position of the sled was not important due to the fact that the sled still is lifted up at the outer side a little bit. But now you should turn the positioning-disk till the steelslidingball slips into the guidingnotch and turning the disk moves the sled forward and backward. Move the sled somewhere to the middle range area and then fix the outer steelbar with the screw and fixingplate at position no. 3.

Now turnback the disk clockwise till the sled is at the rearside and the slideball is just opposite to the drillmark that i explained few pictures above to indicate the position of track 0 like in the picture below at the right side.

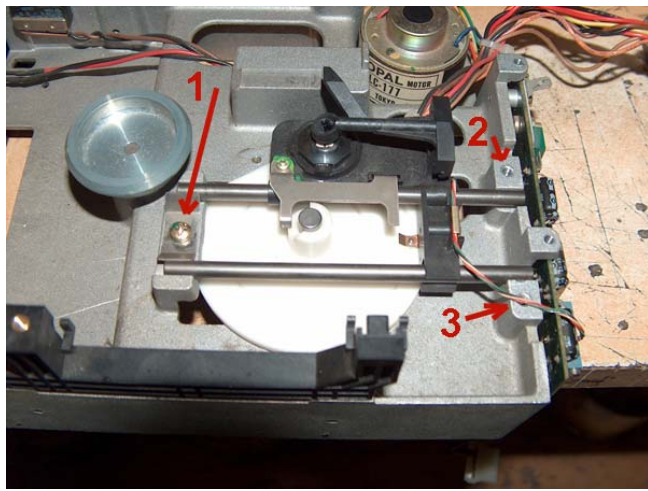

Text is continued in the next cell below.

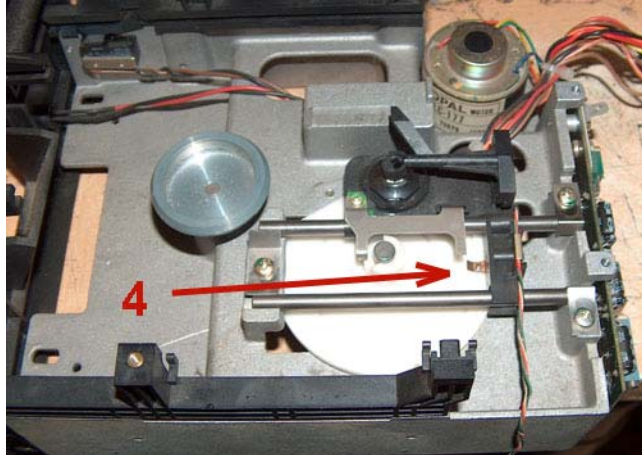

Now we will remount the topframe. Gently let the door slide into the notches (6) of the frontpanel and make sure that the door is in horizontal position to make sure that the 2 metalclamps don't block when slightly sliding in that door in position ... - then lift up the lever that carries the diskpushdownfoam so that the arm of the lever slips to the sliding area (5) of the topframe and then slide the topframe gently to the position so that the hole of the rear steelblades are right on top above of the desired hole that are determined for the screws.

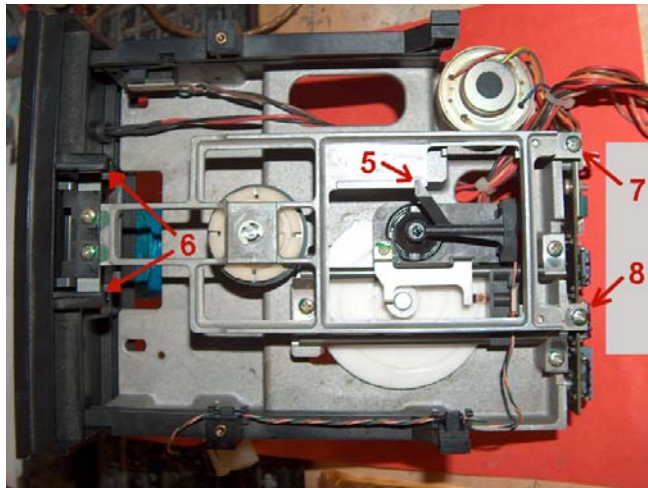

Now tighten the screws 7 and 8 and don't be irritated - when tightening that screws the topframe will lift upwards because this is the purpose of the steelplates at the end of the topframe. After the screws have been tightened you should add a little bit of grease in the notches at position 5 and 6 and shut and open the door to make sure that this does not cause noise and that the mechanic operates smooth and the door locks gently.

Aligning the Track Zero

A - untighten the screws but leave them in the frame.... they just shall be unfastened that far that the Steppermotor can be slided gently to both directions and thereby turns the positioningdisk at the other side smooth..... then follow the instructions below....

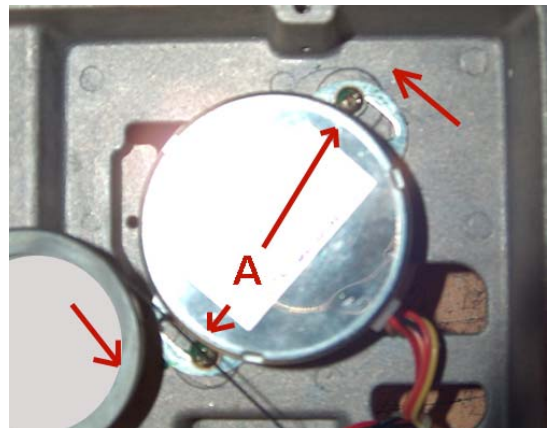

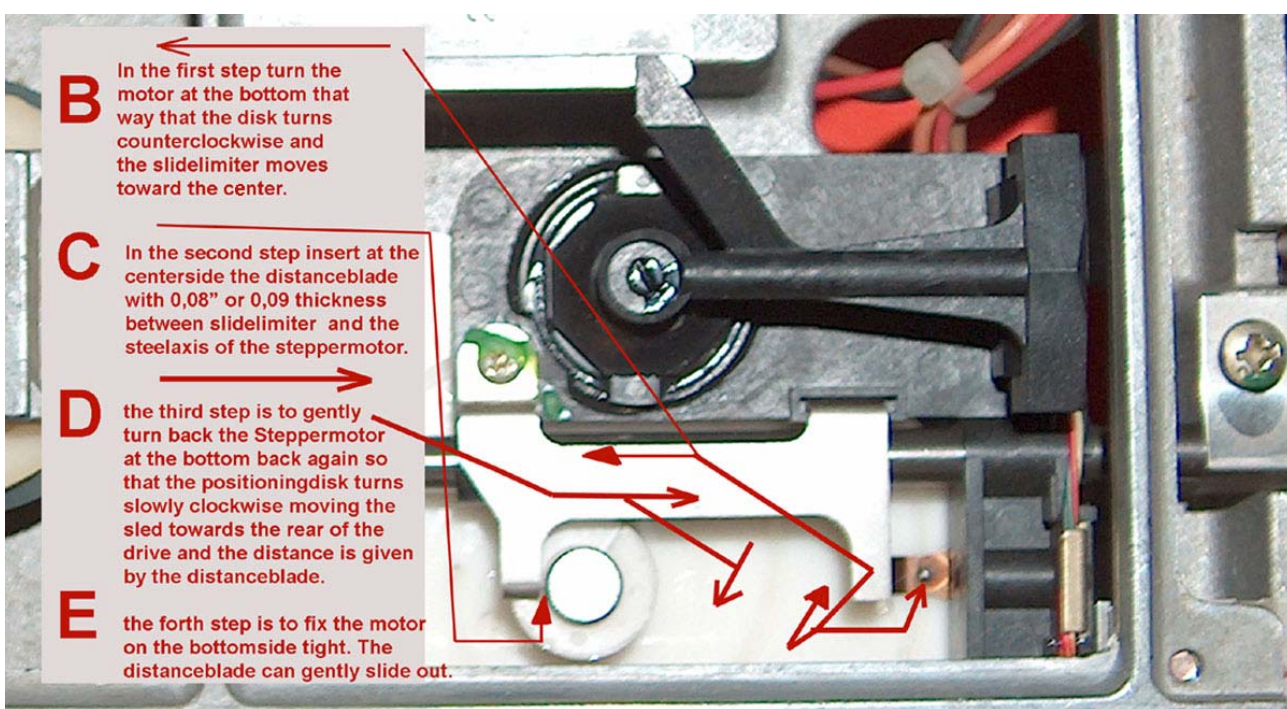

Final remounting before testing with the software

Remount the cable with the wires to the read/write-head very carefully the same way as displayed in the pictures at the right side and take care not to damage that thin and sensitive cables ! The black covers should be fixed in the notches and the cable should slide gently through that covers.... leave at the rearside enough cable that permits the sled to glide along the entire area without getting force applied to the cable.

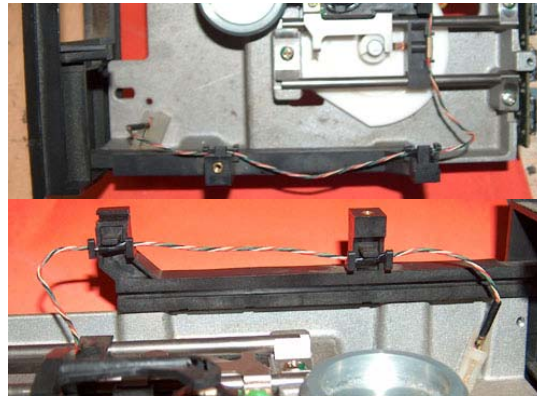

Take the analogboard and position it in the correct orientation and then let the board slide into the notches of the plasticframe at the positions G and then fix the screws at the positions H. Thereafter plug the read/write-head cable to the connector at position I and take care of the correct orientation indicated by the missing pol.

Then plugin the connector with the MotorPCB-cables at position J. Take care of the plastic lockers marked by the arrows ! Then plugin the flatribbon cable at position K. Take care that the side of the cable indicated by a colorside or with the brown or black ribbonside is oriented towards the side indicated in the picture with pin 1.

Remark: Its a common accident that the plug of the flatribbon cable is plugged in the wrong way around at the controller and that kills chips in the electronics !

So it is wise to also mark at this point the cable at the other side by a penmarker and mark the side where pin1 is at that plug at the controllerside too to avoid such an accident in the future !

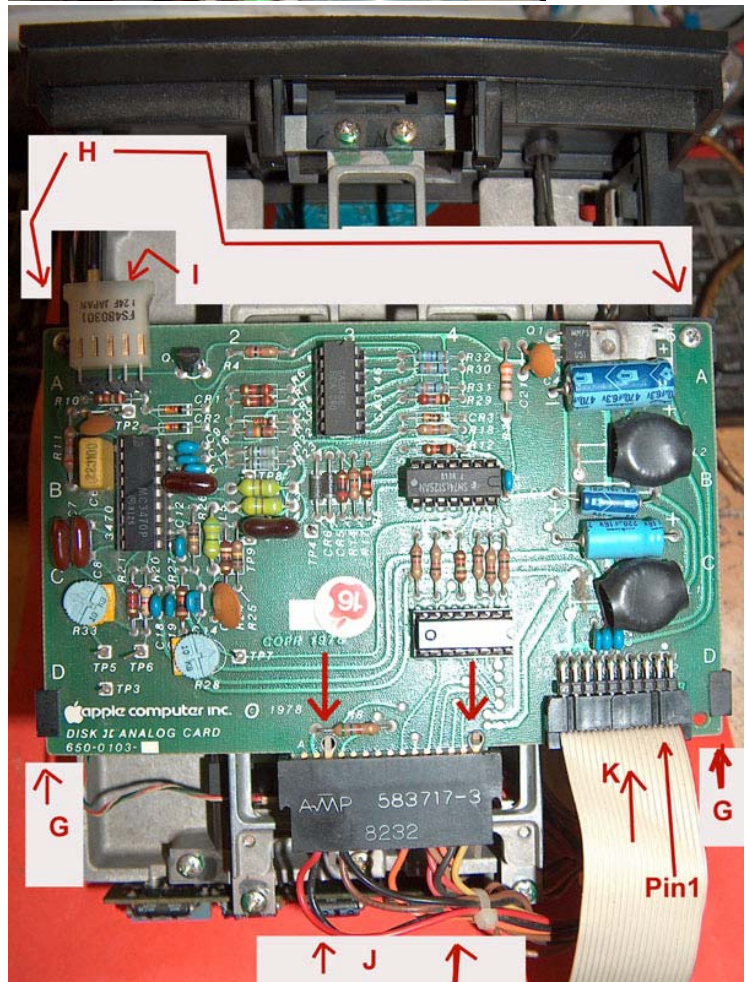

Now we are at the point that we can test the adjustment.

If the drive passes the test it's fine.... otherwise the entire procedure must be repeated with the alternating distance blades.....

Be aware that this test only works with the original disk and that copies of the disk or disks generated with ADT won't work ! In that case the only kind of verification will be, to boot from a disk written by a drive that is known to be aligned correct and then write a disk and try to read that disk completely in the recommended other drive known to be aligned correct !



The only software that was released to the public, that offers a test of the track zero alignment is from Datalife the "Datalife Disk Drive Analyzer" !

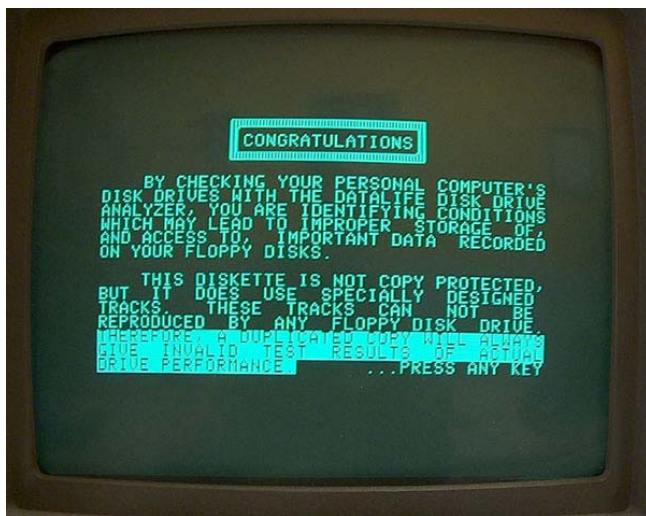

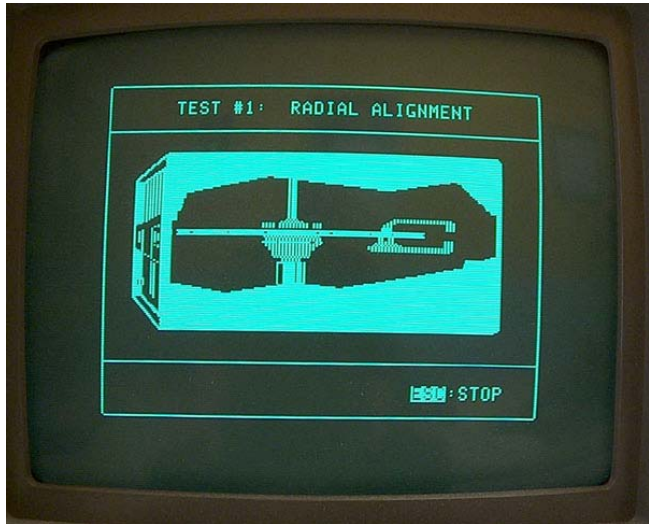

If you went along the above displayed menus and options and received this display - congratulations !
You've solved the task successfully !

This Part is related to the topic if you want to use the oscilloscope instead of the software

First we'll take a look to the analog PCB to recognize at which points we'll have to make the measurements.....

This part of the analogboard contains the electronics related to the read/write head including the read/write-compensation.

This transistor is responsible for switching between the mode read or write

remark: If the cable of the drive has been plugged wrongway around to the controller this chips are most common ones to become fried and damaged!

This part of the analog PCB is designed to "cleanup" the power of the drive coming from the computer from unwanted spikes and other unwanted "dirt" the coils in the black shrinkplastic do the mainpart of the task.

This part of the analogboard is responsible for writing to the disk!

This chip is responsible for the signals leading to the Motor PCB and redirects the signals for the positioningsteppermotor and turning on and off the spinningmotor!

remark: due to age it is not a bad idea to replace these 3 electrolyticcapacitors with new ones (but keep the exact same values and pay attention to the polarity!)

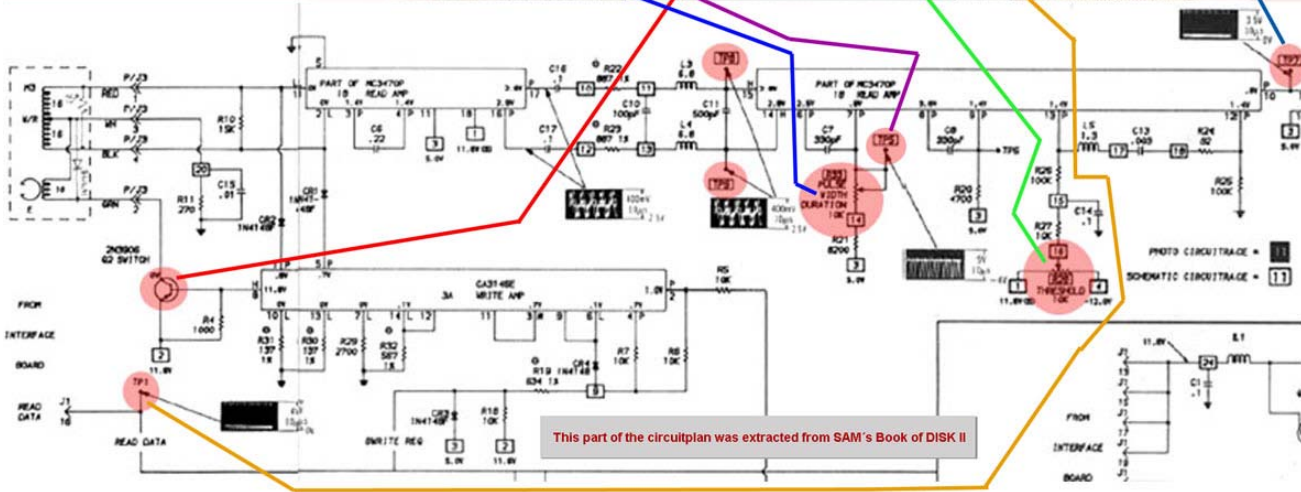
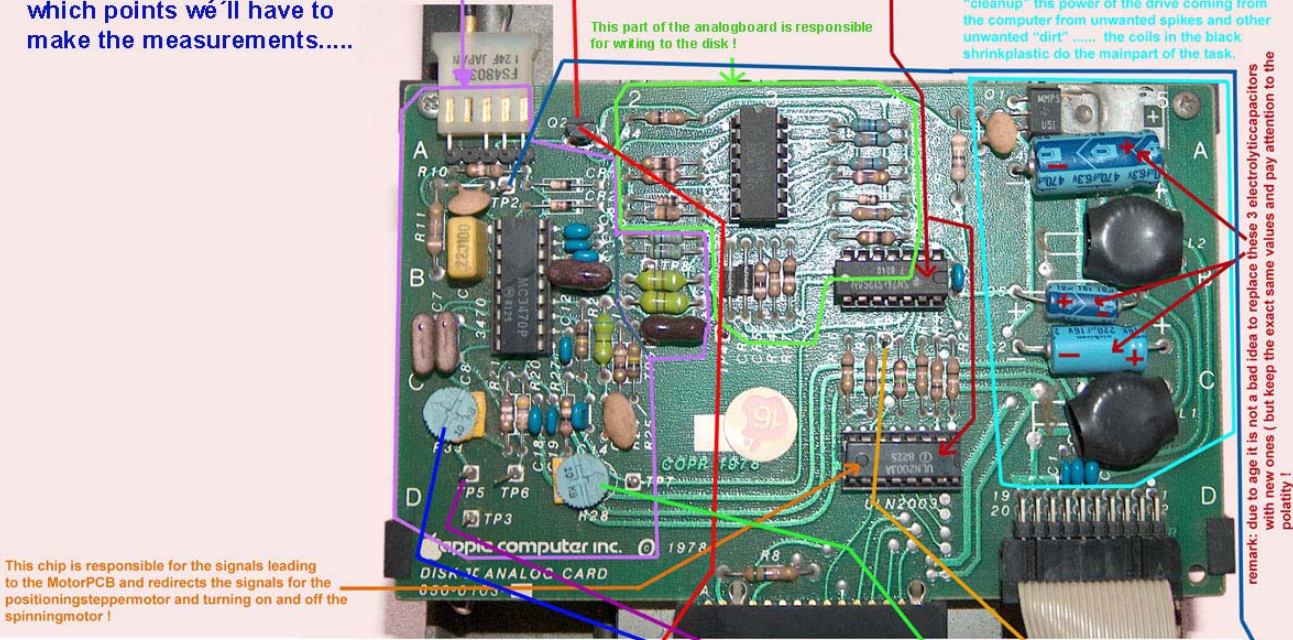

If the Track is aligned correct the signal measured at Testpoint 2 (in the circuitplan at the very right side) in the picture of the analog board at the top left (close to the read/write head connector) should look very similar to the picture of the right side.... - if the alignment is wrong the signal will have less amplitude and the signal will be "noisy" (i.e. the signal won't be clear but rather more "disturbed by spikes" and "rounded edges" at the corners of the rising and falling edges. Also the amplitudes if the single bits will be with "rising" or "falling" rooftops and the bottomline will be very "noisy" to because the read/write head will try reading beside the track....

you might compare this to the driving with a car on the road..... if the car is on the road the noise-level will be low.... - but if you leave the road with 2 tires at one side "off from the road" those tires will be running very noisy in the dirt!

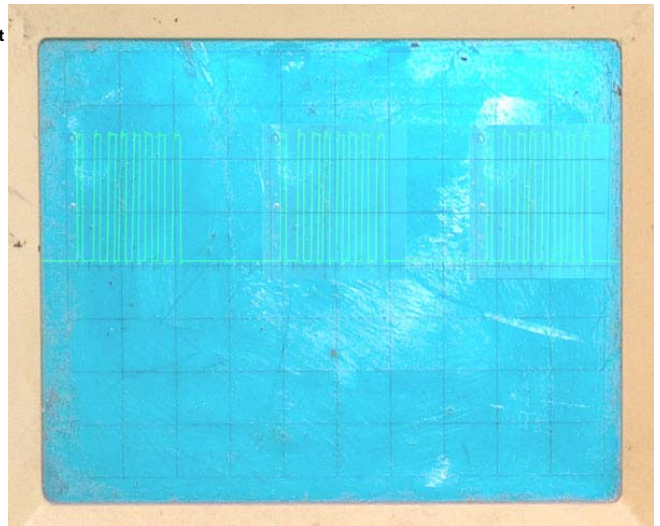

*) Although the DOS (Disk Operation System) from Apple started with diskformat and a drive that only was able to handle 35 tracks - Steve Wozniak was aware of the fact, that within a short period of time drives could be available with more than 35 tracks and that the format of the disk might change (i.e. like the fact that first they started with 13 sectors and later changed to 16 sectors) as it was also performed with the other larger computer of that days (remember about the also common 8" diskdrives with more tracks and more sectors).... not to forget that parts of the DOS-system from Apple were similar to other versions of DOS from those days (it will go to far at this moment to tell stories about the influence of "big copycat Billy "the Kid" Gates" in the development of the DOS-version used by Apple thats a story for

insiders...)

Besides the information of the format on the disk the track 0 also contains the FAT or at least in one sector the information where the FAT is located on the disk (tracknumber and sectornumber ...) - this FAT (File Allocation Table) can be compared to the roadmap together with a addressbook - and it tells the computer which file is located in which track and which sectors and the amount of sectors used to store the file... if the FAT get larger the last sector of the track contains information in which track and sector the FAT is continued.... (this is for example valid for ProDos and there the track- and sectorinformation is converted to "blocknumbers") ... but in the days of DOS and CPM the space granted to the FAT was limited this was one of the reasons that at DOS the size of filenames was limited in length and the amount of files to be stored was limited to maximum of 96 files regardless if the disk was full or not.....

[download this page as PDF-file](#)



[turnback to page about speedadjustment of the drive](#)

[turnback to page about basic mantainance of the DISK II](#)

[continue to the page about advanced adjustment of the offset of the electronical Read/Write-Head compensation cycle](#)

[◀ turn back to the indexpage ←](#)

due to european laws and german court decision:

I hereby declare no responsibility to any "deep links" resulting from the links in this page. I have no influence to the pages linked hereby in this page and the contents in those pages. I therefor can't take any kind of responsibility to contents in the pages, where these links direct the readers browser to nor to the contents resulting from following up links from those pages. The reference to contents by this links is dependent to the status of the date when the links have been set (April 2013) and it might occur that references and contents may change by the fact that domains may have been discontinued from their former owners. In such cases i can't take any kind of responsibility to the changed contents. this is specially valid to banners, advertisements or merchandising links in the targeted pages.

© copyright: Harro Walsh 2013