

SHARP®

Mini-Floppy Disk drive

MODEL **MZ-1F19**

INSTRUCTION MANUAL



PREFACE

Thank you for purchasing Sharp's mini-floppy disk drive MZ-1F19.

Please read this manual thoroughly for proper use.

The MZ-1F19 is an external expansion storage device for Sharp personal computers and contains one mini-floppy disk drive.

Notes:

- 1) The MZ-1F19 contains precision components (LSI chips, etc.) so do not subject it to extreme temperatures, humidity, or dust.
Further, do not use it in locations exposed to direct sunlight. This is to prevent damage to the MZ-1F19.
- 2) Do not yank on the power cord while it is connected. Further, turn off the power switch before disconnecting the power cord.
- 3) Do not hit, drop, or turn over the MZ-1F19.
- 4) Use the MZ-1F19 on a horizontal and sturdy surface.
- 5) Do not use the MZ-1F19 next to noise generating equipment. Use a separate power supply from such equipment. This is to prevent errors due to noise.
- 6) Do not cover the ventilation holes on the MZ-1F19 with objects, cloth, etc.
- 7) Use a soft dry cloth to clean the MZ-1F19 and do not use volatile liquids such as alcohol, benzine, and thinner, or wet rags. This is to prevent damage to the MZ-1F19.
- 8) Make sure to turn on the drive before inserting a floppy disk. If the floppy disk is inserted while the power is off, the hub hole may become damaged and errors may be caused.

Contents

Page

- Parts Identification 2
- Connecting the MZ-1F19 Mini-Floppy Disk Drive to a Computer 3
- Installing Additional Mini-Floppy Disk Drives 5
- Floppy Disk Operation 8
- Floppy Disk Handling 11
- Specifications 12

Parts Identification

- (1) **Disk drive**
Equipped with one drive.
- (2) **Front door lever**
Turn this lever to insert or remove the floppy disk.
- (3) **Disk slot**
Insert the floppy disk through here.
- (4) **Busy lamp**
Lights up when the drive is operating.
- (5) **Power lamp**
Lights up when the power is on.
- (6) **Signal connector (upper)**
Connects with the connecting cable.
- (7) **Signal connector (lower)**
Connects with the extended cable.
- (8) **Power switch**
The power is turned on when this switch is pressed in the "ON" direction.
- (9) **Power connector**
Connects with the supplied power cord.
- (10) **Frame ground terminal**
If ground is available, connect with a grounding wire.

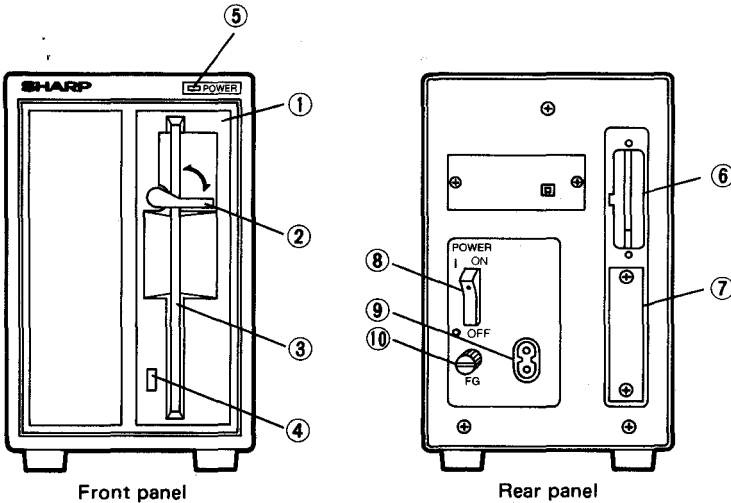

Connecting the MZ-1F19 Mini-Floppy Disk Drive to a Computer

1. The following optional units are required to connect the MZ-1F19 mini-floppy disk drive to a personal computer.

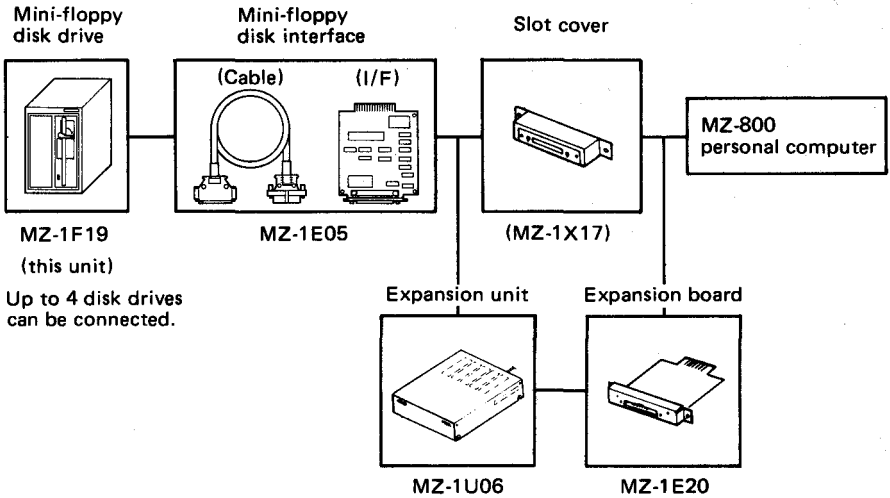

• Protective sheet

A protective sheet is inserted in this disk drive to protect it from damage due to shocks or vibrations during transportation. Remove this sheet before using the disk drive. Preserve it and when the MZ-1F19 is transported, insert it again.

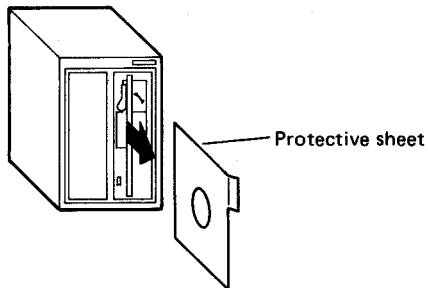

2. Procedures for connecting the MZ-1F19 mini-floppy disk drive to the MZ-800 are as follows.

- 1) Turn off the MZ-800 and its peripheral units.
- 2) Install the optional mini-floppy disk interface MZ-1E05 into the expansion slot on the rear panel of the MZ-800 or the MZ-1U06 expansion unit which is connected to the MZ-800 (1).

Note:

If the ROM chip which is attached to the MZ-700 DISK BASIC is set in the socket on the MZ-1E05 circuit board, remove it.

- 3) By using the cable which is attached to the MZ-1E05 mini-floppy disk interface, connect the MZ-1E05 interface to the upper connector on the rear panel of the disk drive (②). Then fasten the connectors with screws.

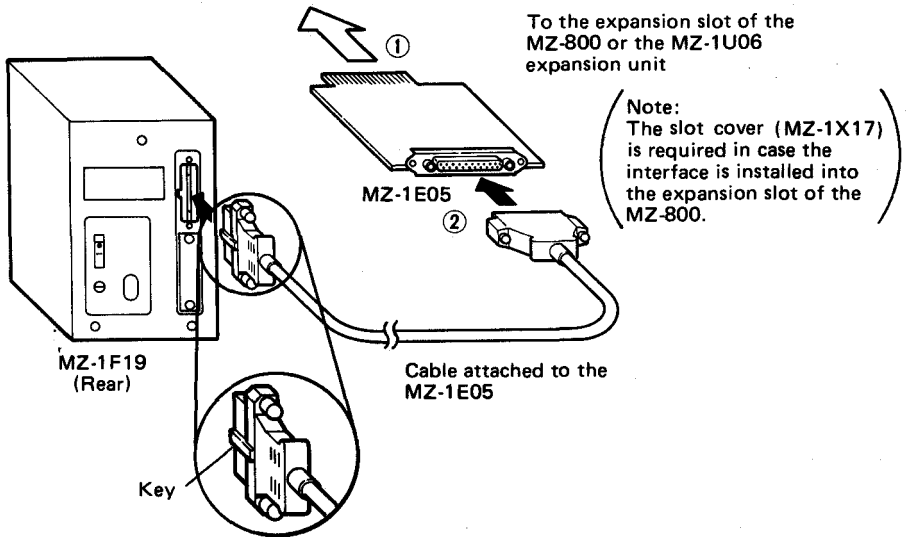

4) When you use the MZ-1F19 connecting to the MZ-800, be sure to connect the earth wire provided for the MZ-1F19 as shown in the figure.

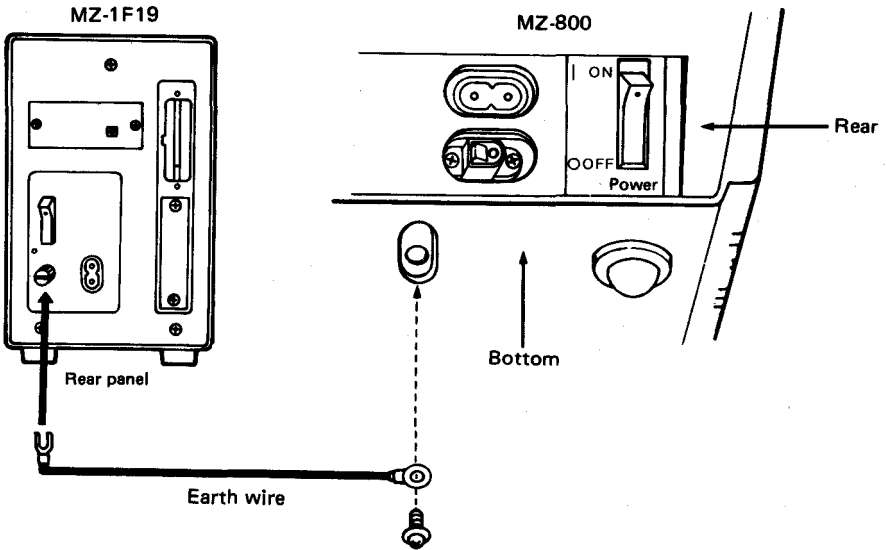

Note:

After connecting the mini-floppy disk drive, be sure to turn on the disk drive first, and then the MZ-800. When two or more disk drives are connected, turn on from the remotest disk drive. For example, when 4 disk drives are connected, turn on the power switch of the drive No. 4, then No. 3, then No. 2, then No. 1 (as for the drive numbers, refer to page 6). Reverse this order when turning off the power switches. If the disk drives are turned on or off in the wrong order, the contents of the disks may be destroyed.

Installing Additional Mini-Floppy Disk Drives

The optional MZ-1C30 cable is provided for connecting additional mini-floppy disk drives.

Note:

The maximum number of disk drives which can be connected is 4.

1. MZ-1F19

- 1) Turn off the MZ-800 and its peripheral units.
- 2) Remove the screw on the left side of the additional disk drive and remove the cover.

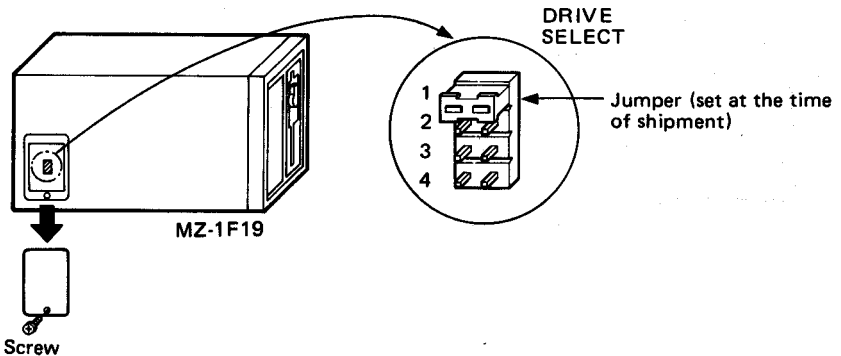

- 3) Reset the DRIVE SELECT jumper on the circuit board according to the drive number. (The drive number is set to 1 at the time of shipment.)

Note:

The jumper setting pattern should be one of the 4 patterns on the next page.

- 4) Replace the cover and screw it.
- 5) Remove the lower connector cover on the rear panel of the disk drive which is already connected, and plug the connector with the name label of the MZ-1C30 cable into the lower connector. Connect the other connector of the cable to the upper connector of the additional disk drive. Fasten both connectors of the cable with screws. Follow the same procedures when the third and fourth disk drives are connected.

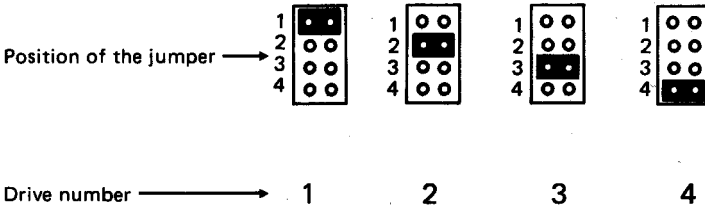
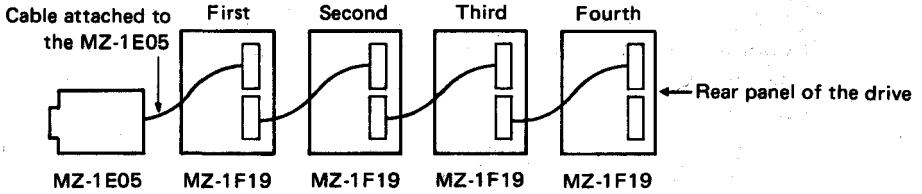

The drive numbers are as shown above. Stick the drive No. labels to the drives. (The software uses these drive numbers to identify each drive.)

2. MZ-1F02

Note:

The MZ-1F02 must be used as the first and second disk drives.

- 1) Turn off the MZ-800 and its peripheral units.
- 2) Disconnect the cable from the MZ-1F19.
- 3) Remove the screws on the left side of each disk drive unit to remove the cover.
- 4) Set the DIP switch and jumper as shown on the next page.

Note:

Do not set the DIP switch and jumper to the position other than that shown on the next page.

- 5) Remove the terminator set in the socket located above the DIP switch of the MZ-1F02.

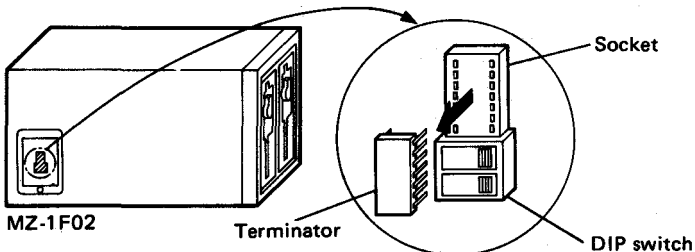

- 6) Replace each cover.
 - 7) Connect the cable which was disconnected at step 2 to the upper connector on the rear panel of the MZ-1F02 and fasten the connector with screws.
 - 8) Remove the lower connector cover on the rear panel of the MZ-1F02. Use the MZ-1C30 cable to connect the MZ-1F02 and MZ-1F19 by plugging the connector with the name label of the cable into the lower connector of the MZ-1F02 and the other connector into the upper connector of the MZ-1F19. Fasten both connectors of the cable with screws.
- * Take the same manner to connect the fourth disk drive.

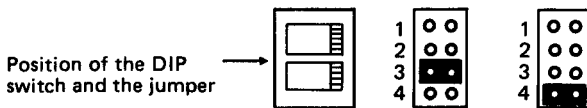
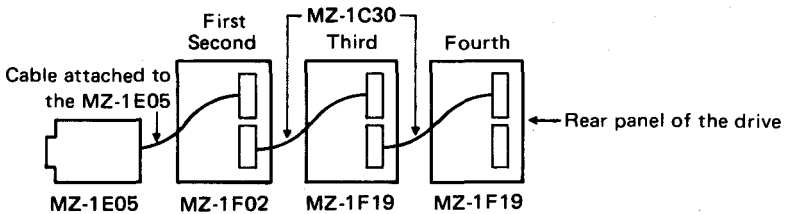

Drive number → 1, 2 3 4

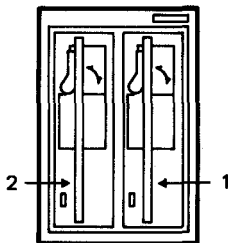

Floppy Disk Operation

(1) Floppy Disk

This floppy disk drive uses a 5-1/4 (5.25) inch **double-sided, double density mini-floppy disk** for the storage media. Its appearance is shown below. It consists of a magnetic sheet covered by a jacket and is called a floppy disk.

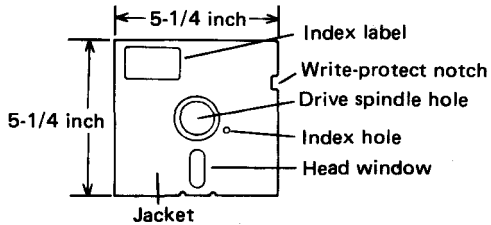

Drive spindle hole When the disk is inserted in the drive, the drive's spindle clamps into this hole to rotate the disk.

Head window The read/write head comes in contact with the disk to read or write data through this window. The head is moved from one track to another by a stepping motor.

Index hole This hole is used for determining the head's position around the circumference of the disk.

- It is recommended that you buy blank disks at the same store where you bought this floppy disk drive.

[Model] **MZ-6F01** (Double-sided, double-density disk, 1 pc)

(2) Inserting the Floppy Disk

1. The floppy disk can be inserted when the front door lever is turned to its vertical position.
2. With the index label side (front surface) on the left and the head window away from you, insert the floppy disk into the drive. This is the only way to insert the floppy disk for proper operation. (See figure below.)
3. Gently push the disk until it stops and turn the front door lever to its horizontal position. Always make sure to turn the lever to its horizontal position after inserting a floppy disk. This drive will not operate if the lever is vertical.

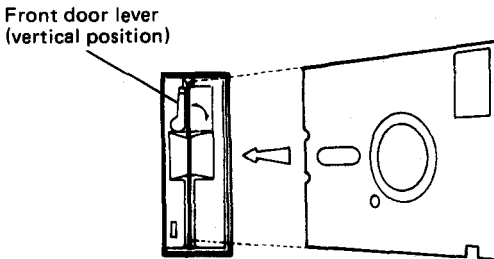

Notes:

- 1) The lever will not turn if the floppy disk is not completely inserted. Do not forcibly turn the lever. Instead, properly reinsert the floppy disk before you turn the lever.
- 2) Make sure to turn on the drive before inserting a floppy disk. If the floppy disk is inserted while the power is off, the hub hole may become damaged and errors may be generated.
- 3) Turn off the power switch after turning the front door lever to its vertical position. This prevents the contents of the floppy disk from being destroyed by misoperations at the time of power off.

(3) Write-Protect Notch

The write-protect notch is used to prevent erasure of data already written on the floppy disk. Covering this notch with an opaque seal inhibits writing to the floppy disk. However, the floppy disk can still be read. Some floppy disk supplied by Sharp called the master has this notch covered by a seal. Since the notch is covered to avoid trouble due to erroneous operation, do not remove it unless necessary. Do not cover the notch with a seal if the floppy disk is always written. The disk cannot be written if the notch is covered.

Write-protected disk

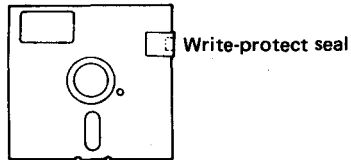

(4) Data Read/Write Operation

All that you have to do with the disk drive are to turn on and off the power and to insert and remove the floppy disk. The data read/write operation is controlled by the computer.

For details, refer to the manual for the software being used.

Floppy Disk Handling

Observe the following precautions for long use of your floppy disks.

- Do not touch, soil, or scratch the recording surface (through the head window) to prevent disk errors due to damaged medium.
- Do not apply alcohol, thinner, freon, or other solvents to the magnetic surface or disks.
- Do not bend or fold the floppy disk to prevent damage.
- Never place magnetized materials (such as magnets) near floppy disks. Magnetism will destroy the data on a floppy disk. For the same reason keep magnetic field generating equipment (such as motors) away from floppy disks.
- Write on the index label before attaching it on floppy disk jacket or use a soft-tipped instrument such as a felt-tipped pen. The floppy disk may become scratched if a hard-tipped instrument such as a pencil or ball-point pen is used.
- Do not place anything or use paper clips on floppy disks so that the jacket will not become deformed.
- Avoid eating, drinking, or smoking around the floppy disks.
- Do not use floppy disks which have been contaminated by spilled liquids such as coffee.
- Always keep the floppy disk in its protective envelope and vertically in its storage box when not in use. This is to prevent problems caused by dust.
- Do not place floppy disks in direct sunlight or near heaters. The heat will deform the jacket and make the floppy disk unusable.
- Use floppy disks within the temperature range noted on the envelope. Since the storage environment and operating environment may differ, leave the floppy disk(s) in the operating environment for 30–60 minutes before using.
- Properly insert floppy disks into the drive unit.
- Make sure to turn on the drive before inserting a floppy disk. If the floppy disk is inserted while the power is off, the hub hole may become damaged and errors may be generated.

Specifications

Model	: MZ-1F19
Recording capacity	: 320 K bytes
Number of tracks	: 40 tracks/side
Number of sectors	: 16 sectors/track
Storage medium	: 5-1/4 inch double-sided, double density floppy disk
Power supply	: Local voltage, 50/60 Hz
Power consumption	: 20W
Operating temperature	: 10–35°C
Operating humidity	: 20–80% (without condensation)
External dimensions	: 118(W) x 331(D) x 189(H) mm
Weight	: 5.1 kg
Accessories	: Instruction Manual, drive number seals, power cord. Earth wire

This apparatus complies with requirements of BS 800 and EEC directive 82/499/EEC.

Dieses Gerät stimmt mit den Bedingungen der EG-Richtlinien 82/449/EWG überein.

Cet appareil répond aux spécifications de la directive CCE 82/499/CCE

Dit apparaat voldoet aan de vereiste EEG-reglementen 82/499/EEG.

Apparatet oppfyller kravene i EF direktivet 82/499/EF.

Questo apparecchio è stato prodotto in conformità alle direttive CEE 82/449/CEE.

SHARP CORPORATION
OSAKA, JAPAN

Printed in Japan
Gedruckt in Japan
Imprimé au Japon
Stampato in Giappone
© 1984 SHARP CORPORATION
4K1.00 (TINSE1286ACZZ)②